

Overview

- equinox /e·qui·nox/ ekwe,nāks, noun 1. the time or date (twice each year) at which the sun crosses the celestial equator, when day and night are of approximately equal length (about September 22 and March 20)
- Equinox Series was originally designed to echo reception desk shapes, give direction, and create work light in an office space. After the office, Equinox Series has made its way to showcasing city transportation areas, hospital common areas and more.
- DESIGNER SELECTIONS
- Equinox Series has a 5" profile with at least 250 degrees of white acrylic.
- Equinox Series can be pendant mounted, using cables or ¼" stems.
- Glance under appropriate categories for Equinox shapes IE; Pendent Curves or Pendent Rings.
- Equinox Series is available in straight and curved runs and also rings. Because we bend the full 5" tube there are no seams like other manufactures. This does limit us to certain radius dimensions so please consult our factory as to the shapes you're looking to accomplish.
- Complex turns are achieved by using milled aluminum joiners.
- Equinox Series has multiple choices for canopies and colors, just scroll down for your choices. Also note, all drivers are remote.
- Equinox Series is available in almost any CCT available in the market, we've selected the most popular, but don't let that stop you from asking for something different.
- Equinox Series qualifies as "Made in America" and "American Made", and it is also part of our ECO sustainable end of life program.
- For all: ies files, pictures, instructions, rfa files, and warranties...scroll to bottom.

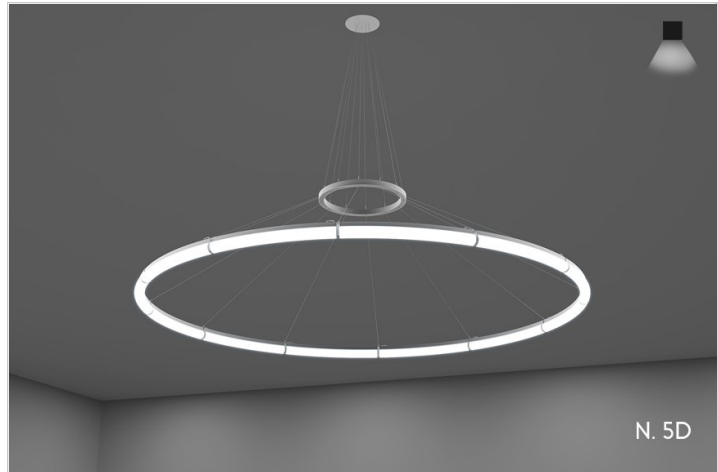

Equinox Ring

PENDANT RINGS

TYPE
PROJECT

Ordering Format

PART NUMBER: EQXR-PD

Size	Lumens Direct	CCT Available	CRI Available	Direct Optics
20 = 20 Feet CR = Custom Size, consult factory add in notes	D3 = 350 Lumens D5 = 500 Lumens D7 = 750 Lumens	27 = 2700 Kelvins 30 = 3000 Kelvins 35 = 3500 Kelvins 40 = 4000 Kelvins TW = Tunable White-27k-56k/0-10v Control	80 = 80-85 CRI 90 = 90-95 CRI	OW = Opal White Direct Lens
Mounting	Driver / Voltage	Fixture Finish	Canopy/Power Cord Color	Options
CLGCR = Custom Canopy Ring for weight distribution (Non-Lighted)	ND 1 = Non-Dim Universal 120VAC ND 2 = Non-Dim Universal 277VAC ZT 1 = 0-10v dimming 120v 1% ZT 2 = 0-10v dimming 277v 1% CC = Custom Control - add in notes	W = Standard White BK = Standard Black SVR = Standard Silver3 RAL = Enter RAL# or Pantone# in notes PA = Plated Aluminum-enter plated finish in notes CW = Standard Wood Finish - see wood PN # enter in notes. SW = Special pattern submitted by designer AA = Anodized Aluminum -enter PN in notes section	CWPW = Canopy White/Power Cord White CWPB = Canopy White/Power Cord Black CBPB = Canopy Black/Power Cord Black CBPW = Canopy Black/Power Cord White	AWN = Lutron Athena Wireless Node (RF only) AWNS = Lutron Athena Wireless Node (with Sensor) EMD = Emergency Driver - Battery Backup 120-277VAC IW = Inverter Wiring OS = Occupancy Sensor

NOTES

ORDER NUMBER:

Equinox Ring

PENDANT RINGS

TYPE

PROJECT

Construction & Mounting

HOUSING

Extruded aluminum rings are supplied in our standard nominal sizes of 3 ft., 4 ft., 5 ft., and 6 ft.. Custom sizes are also available in our standard Anello. Each ring can be shipped containing from 2-4 sections that are locked together with ring clamps for perfect joint connection. Easy access to driver and LED boards.

REFLECTOR

Integral powder-coated LED housing with excessive reflectivity for increased lumen output

FINISH

Standard powder-coated colors are white, black and silver. Custom processed wood finishes, aluminum anodized finishes, chrome/gold plating and custom finishes are available as well. We also accept RAL and Pantone numbers for powder-coating color choices. Contact factory for wood finishes.

OPTICS

Semi-Flush, lay-in acrylic lens formulated for LED light sources. Lift and shift lens.

MOUNTING

Cable mounting with various size canopies and power feeds. Cable uses gripper style locking for field adjustments 48" standard. Canopy mounts to standard J-box and larger sizes may require Picasso re-enforced canopy.

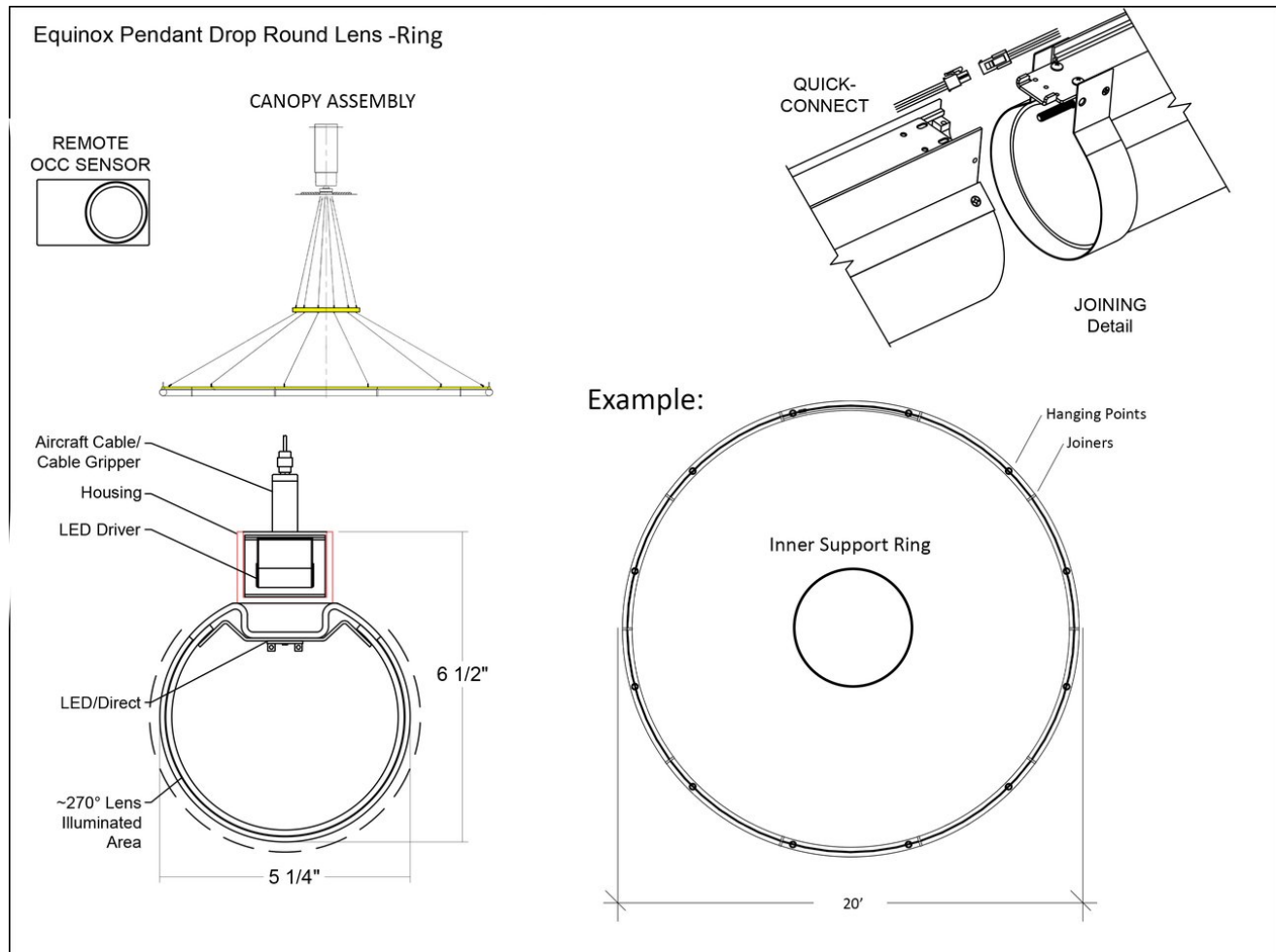

Equinox Ring

PENDANT RINGS

TYPE

PROJECT

Standard Finishes



White W Black B Silver SVR

Anodized Aluminum - Premium Finishes

xxxx-B for Aluminum to be Brushed



Anodized Black AABK Anodized DK. Bronze AADB Anodized LT. Bronze AALB Anodized Champagne AALC Anodized Clear AACL

Custom RAL - Custom finishes go to: tiger-coatings.com **Add 8 to Notes**



Plated Aluminum - Premium Finishes



Antique Brass PAAB Polished Chrome PAPC Polished Gold PAPG

Wood - Premium Finishes

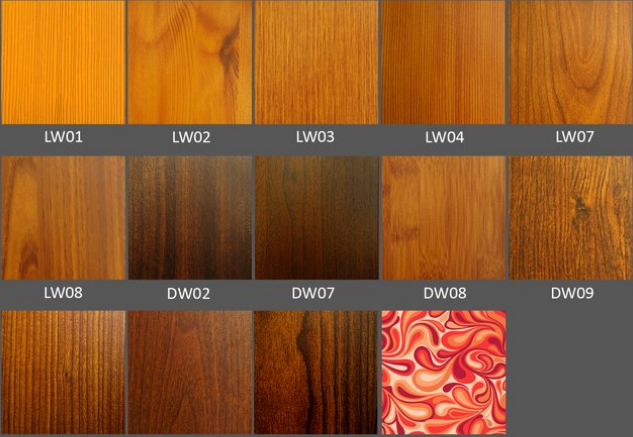

LW01 LW02 LW03 LW04 LW07

LW08 DW02 DW07 DW08 DW09

DW10 DW11 DW12 Consult Factory

Standard Finishes - colors are powder coated and do not add to delivery lead time.
 Anodized Aluminum - can be smooth or brushed, color can vary fixture to fixture and adds 4-5 weeks to lead time. Anodized finish is limited in fixture size.
 Plated Aluminum - is a mirror finish in chrome and gold and adds 4-5 weeks to lead time.
 Woods Finishes - so realistic, wood finish can add up to 4-5 weeks to lead time.

Electrical / Driver

- Drivers - Our drivers are specifically selected based on fixture application to ensure ultimate reliability and long life. We use only UL recognized brands of LED drivers. Our LED drivers feature HPF (high power factor), universal voltage 110 - 277 VAC and include 0-10V dimming. Please note, 277v has longer distances from power feed to power feed then 120v.
- If required, we can supply premium drivers such as Lutron, Eldoled and others upon request. Advanced control systems compliant drivers such as POE, DALI, DMX, etc. are also available, please consult factory.
- Rated life (90% survivorship) of 50,000 hours at 50° C max. ambient (and 70° C max. case) temperature. At maximum driver load: Efficiency >84%, PF>0.9, THD
- Our LED drivers feature HPF (high power factor), universal voltage 110 - 277 VAC and include 0-10V dimming.
- Emergency drivers are factory installed as an option, long life, high temperature, recyclable Ni-Cad battery pack with test switch and charge indicator. EMR is minimum of 90 minutes operation to meet code.
- POE - We are working with Molex/Igor POE systems. We can add a POE driver into our fixtures or remote them. Based on the fixture you select, we will notify you (or you can contact the factory) to see if we can install the P-driver or the P-driver needs to be remote. Just add POE1 in the spec and we will advise. Please keep in mind you need to specify a complete POE control system before specifying POE1.

LED Performance

LED Output	CCT Color Temp	Watts	Lumens	Lumens per Watt	CCT Multiplier
Medium	3000	4.63 WPF	500 LPF	108	x

- The table above is a quick reference. When calculating loads make sure you add direct and indirect LPW to get total wattage. Please refer to photometric report for detailed information.
- Our light engines are precisely designed for optimal operation of LED assemblies.
- Our standard LED's CCT (correlated color temperature) range is 2700K to 4000K. Other CCT values are available upon request.
- We log LED bin codes for each project we supply to ensure color consistency and keep a record of those projects for future reference.
- CRI offered is 80+, and 90+ Note: on 90+ CRI use .85 multiplier
- Tunable white, warm dim and other special LED colors available.
- Custom Lumens Available
- We design our own printed circuit boards to ensure high luminescence efficiency, low thermal resistance and long-term reliable operation.
- Light engines are easily replaced.
- We use only recognized brand LED's with 3 SDCM (standard deviation color matching) with high color consistency. 2 SDCM available upon request.
- If you require a special LED manufacturer, please contact us. LED chip manufacturers used by Picasso are primarily (but not limited to) Nichia, Cree and Samsung.
- LRP - "LED Reel Program" – LED's for printed circuit boards come on reels' like old 8mm projectors and they're sold in lots just like fabric. At Picasso Lighting, we have a program where we make sure all of your reels come from the same lot for each project. This ensures excellent color consistency in large open spaces.
- LED life is rated at 50,000 hours

Certifications & Warranties

- Limited five-year limited warranty on all products that are installed according to the product's specifications. Fixture must be properly installed by qualified licensed electricians, who meet and understand local installation requirements. Proper ambient conditions are to be met. The normal indoor temperatures of 50-90 degrees F, no more than 95% RH and sufficient air flow are required. Fixture should not be modified, and no maintenance or repairs should be performed without the written authorization from Picasso Lighting.
- We manufacture based on approved spec sheets and submittals signed by the customers. Change orders must be in writing and will delay delivery.
- Picasso Lighting reserves the right to repair or replace a defective product with another product with a similar design and the same or better performance, or to refund the distributor for the purchase price.
- Warranty does not cover damage caused by transportation, damage caused by using the fixture in an area it is not UL rated for, damage caused by negligence, lack of maintenance, attempts to repair by unqualified or unauthorized personnel, by using non-original accessories/parts, fixtures installed in systems without power surge protection.
- Picasso Lighting must receive in writing any complaints regarding the defective products, no later than 3 weeks from delivery addressed to: ttoledo@picassoltg.com. Picasso Lighting will send a field technician to the site to evaluate the said defective product or may require product to be sent back to the factory for repair. The customer is responsible for the costs of disassembly and reassembly. We do accept field repairs and replacement labor from licensed electrical contractors but not without a written agreement signed by Picasso Lighting official. Failure to adhere to all warranty and certifications will void any recompense and the warranty.
- IBEW USA Union All fixtures are IBEW manufactured

Equinox Ring

PENDANT RINGS

TYPE

PROJECT

and assembled in the USA. UL listed for dry and damp locations.



Note: Picasso lighting industries, LLC reserves the right to make any design changes which will not affect the overall appearance or performance of the product. All ceilings to be adequately reinforced by others. All fixtures to be wired by licensed electrician only. The information contained herein is the sole property of Picasso Lighting Industries, LLC and may not be used without prior written consent of Picasso Lighting Industries, LLC. The 'USGBC member logo' is a trademark owned by the U.S. Green building council and is used by permission. The logo signifies only that Picasso Lighting Industries, LLC is a USGBC member; USGBC does not review, certify, or endorse the products or services offered by its members.