

# SURFACE MOUNT LED EXIT SIGN

EMERGENCY BATTERY BACKUP

## INSTALLATION & OPERATION INSTRUCTIONS

### Package Contents

Part	Description	Quantity
1	LED Edge-Lit EXIT Sign	1
2	Canopy	1
3	Hardware Bag	1

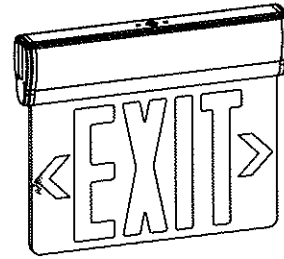

### Warnings and Cautions

## IMPORTANT SAFEGUARDS

### READ AND FOLLOW ALL SAFETY INSTRUCTIONS.

1. Review the diagrams thoroughly before beginning. If you feel you do not have electrical wiring experience, refer to a do-it yourself wiring handbook or have your fixture installed by a qualified licensed electrician.
2. All electrical connections must be in accordance with local codes, ordinances, and the National Electric Code. If you are unfamiliar with methods from installing electrical wiring, secure the services from a qualified licensed electrician.
3. Before starting the installation, disconnect the power by turning off the circuit breaker or by removing the appropriate fuse at the fuse box. Using the light switch to turning the power off is not sufficient to prevent electrical shock.
4. Do not use outdoors.
5. Do not let power supply cords touch hot surfaces.
6. Do not mount near gas or electric heaters.
7. Use caution when servicing batteries. Battery acid can cause burns to skin and eyes. If acid is spilled on skin or eyes, flush acid with fresh water and contact a physician immediately.
8. Equipment should be mounted in locations and at heights where it will not be subjected to tampering by unauthorized personnel.
9. The use of accessory equipment not recommended by the manufacturer may cause an unsafe condition.
10. Do not use this equipment for other than its intended use.
11. All servicings should be performed by a qualified personnel only.
12. Allow battery to charge for 24 hours before first use.

## SAVE THESE INSTRUCTIONS

### ELECTRICAL CONNECTIONS

- Make the proper supply wire connections.
- If using 120VAC, connect the black and white wires to the building utility.
- If using 277VAC, connect the orange and white wires to the building utility.
- Cap off unused wires. In all cases, use standard wire nuts to connection to wires.

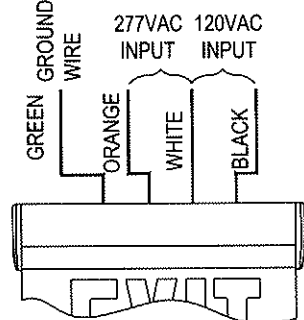

### DETERMINE DIRECTION

- If need indicator, remain indicator and remove instruction film.
- If no need indicator, remove indicator and instruction film together.



# Mounting Instructions

**NOTE:** First turn off electricity.

## Surface Ceiling & Wall Mounting

1. Attach crossbar to junction box, using screws if needed. (screws are not provided)
2. Use screwdriver open front cover to connect battery connector.

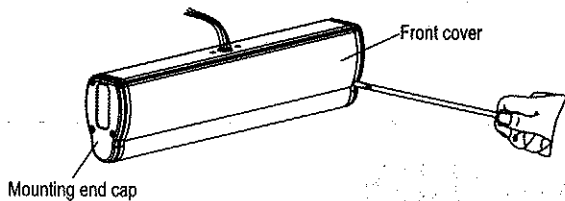

3. Feed AC supply wires through canopy center hole.
4. Assemble canopy onto main body assembly with (2) PM4\*15 screws(supplied) and make proper wire connections. (See ELECTRICAL CONNECTIONS).
5. Use (2) PM4-40 screws (supplied) tighten canopy to crossbar.

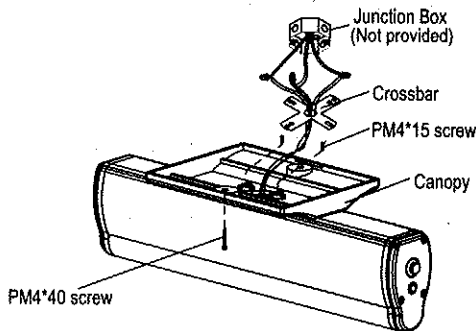

6. Insert EXIT panel into main body assembly gently. If EXIT panel is for single face, make sure EXIT letter direction is right.

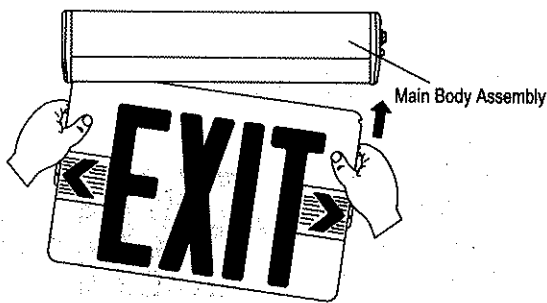

7. Determine direction for chevron placement. (See DETERMINE DIRECTION)

8. The unit can be installed on any surface, you may rotate the EXIT panel in any angle from 0° to 180°, Ceiling mounting rotate 90° become Wall mounting.

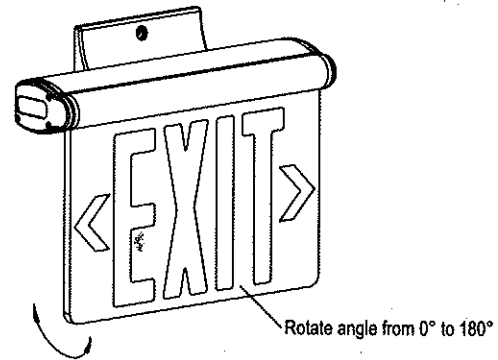

## Surface End Mounting

1. Attach crossbar to junction box, using screws if needed. (screws are not provided)
2. Use screwdriver open front cover to connect battery connector.
3. Remove the hole plug from mounting end cap.
4. Pull out all AC supply wires and feed wires thru the center holes of mounting end cap and then canopy.
5. Reference 4 - 7 step in surface ceiling & wall mounting above for surface end mounting.

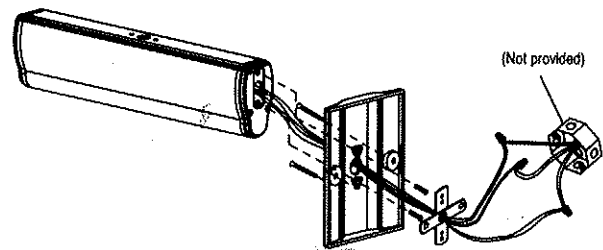

6. The unit can be installed on any surface, you may rotate the EXIT panel in any angle from 0° to 180°.

## Assembly Drawing

